

DEVELOPMENT OF NEW PHOTOMETRIC STANDARDS BASED ON HIGH POWER LEDs

Eugene A. Ivashin¹, Boris B. Khlevnoy¹, Stanislav S. Shirokov¹, Eugene V. Tyshchenko²

¹ *The All-Russian Research Institute of Optical-physical Measurements
(VNIIOFI Federal State Unitary Enterprise)*

² *The Moscow State University of M.V. Lomonosov
E-mail: ivashin@vniiofi.ru*

ABSTRACT

The paper describes the study design and results on stability and photometric characteristics of new powerful (> 10 W) thermally stabilised LED standard light sources for transmission of luminous flux and luminous intensity units, and in the long term full radiation flux.

Keywords: light emitting diode (LED), Chip-On-Board (COB), luminous intensity, luminous intensity spatial distribution, luminous flux, temperature stabilisation with feedback

1. INTRODUCTION

In the recent past and even today, incandescent lamps are widely used for transfer of luminous intensity and luminous flux unit size. Use of incandescent and halogen lamps is associated with certain difficulties: it is difficult to find and select standard specimens with required parameters of stability and luminous intensity or levels of luminous flux; it is not possible to use one standard specimen for various levels of luminous flux with various parameters of power supply. In addition, the production of incandescent lamps continually decreases as the LED industry develops [1]. The use of thermally stabilised LEDs has an important advantage for companies manufacturing LED based products. When product quality control is based on LEDs, calibration of the measurement equipment using LEDs with similar spectral composi-

tion allows increasing the measurement accuracy without time-consuming spectral measurements and, hence, without increasing time for the processing of results[2-4].

To replace lamps like SIS40-100, SIS107-500, SIS107-1000, SIP 24-10, SIP 107-500, SIP107-1000 and SIP 107-1500, which are traditional luminous standards in Russia, with standard light sources – thermally stabilised LEDs developed at the VNIIOFI are proposed.

2. SELECTION OF LIGHT EMITTING DIODES

The structure of the thermally stabilising case for the LED was developed in such a way that when changing LED types during production, the manufacturer could replace them with any light emitting diode. This will make it possible for manufacturers of lighting and other LED based devices to change a set of standard calibration specimens in the shortest possible time.

LEDs of different power and spectral composition were selected as experimental samples.

Experiments for the study of light parameter stability were conducted using specimens with the following electric powers: 1 W, 10 W, 36 W and 78 W. The samples were selected to understand different methods of removing heat: LEDs of 1 W and 10 W with aluminium heat sink, and LEDs of 36 W and 78 W with ceramic heat sink. Before assembling the thermally stabilised source structures,

the LEDs underwent preliminary annealing for 250 hours [5.6]. After final assembly of the structures, the LEDs were annealed for an additional 100 hours in operating mode (with the temperature stabilisation).

3. CONSTRUCTION DESCRIPTION

3.1. Light source (LS)

The structure provides for two types of standard specimens: with and without optical elements homogenising spatial distribution of radiant intensity spectral concentration. Application of optical elements to decrease non-uniformity of the spatial distribution of radiant intensity spectral concentration is caused by the necessity to calibrate goniophotometers using these standard specimens.

A platinum thermal resistor *Pt-1000* was selected as the diode temperature control detector. This choice is based on its high stability and reproducibility. Peltier elements are used for active temperature stabilisation.

The radiators selected consist of industrially made products according to the expected dissipation power; they are finally treated later in the structure assembly process. The inner heat-conducting elements are made of copper. The output aperture diaphragm is manufactured out of brass. The external case is made of plastic.

LS structures with optical elements and without optical elements are presented in Fig. 1.

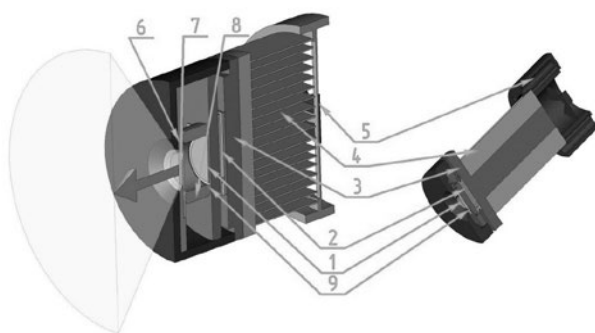

Fig. 1. A device for thermally stabilised LSs based on COB (*chip-on-board*) LEDs with optical elements (left) and without optical elements (right)

- 1 – COB LED; 2 – Peltier element; 3 – copper base for Peltier element; 4 – radiator; 5 – fan; 6 – aperture diaphragm; 7 – matte glass; 8 – polytetrafluorethylene tube; 9 – point with a known thermal resistance before LED crystals (a thermal resistor is installed at this point)

COB LED1 is placed on a copper plate, which is the thermal accumulator in order to improve parameters of thermal stabilisation and smooth temperature change for the LED itself. To provide angular uniformity of radiation spectral characteristics in the first type LS structure (Fig. 1, at the left), special optical elements are applied as tubes of polytetrafluorethylene (plastic fluor) 8 and of MC-23 glass 7 with matting. The aperture diaphragm 6 is the LS output window. In the structure with additional optical elements (Fig. 1, on the left), the diameter of the output window is 20 mm; in the second type, the diameter of the output window depends on the LED used. The copper plate with the LED is placed on Peltier element 2, which provides for the LED temperature adjustment. The Peltier element is installed on copper plate 3 with radiator 4, which is actively cooled by fan 5. The radiator surface area depends on the stabilised LED power and on the applied Peltier element.

3.2. Control unit

3.2.1. Block diagram

A flow chart of the thermally stabilised LED LS control unit is given in Fig.2.

The control device consists of a current source supplying the LED, Peltier element power supply, temperature measurement unit and a control unit adjusting the Peltier element power supply parameters depending on the LED temperature.

The control device can be connected to a personal computer to implement additional algorithms for LS stabilisation. Besides, when connecting to the

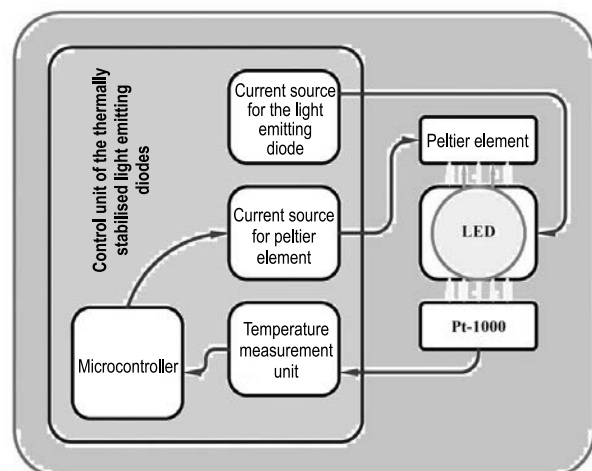

Fig.2. Flow chart of the LS control device

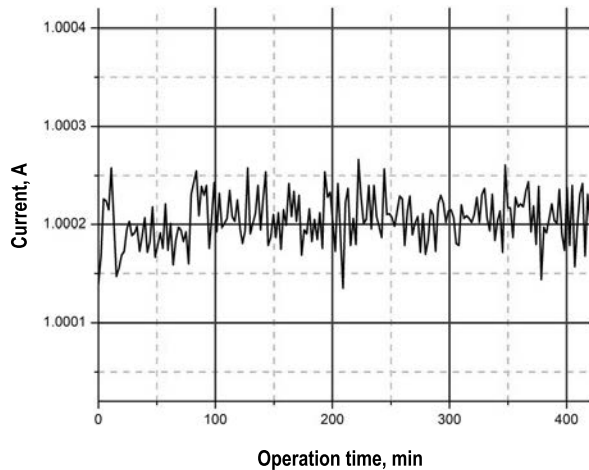

Fig.3. Stability of the current source supplying the LED

personal computer, a program control is possible for the LED power supply, Peltier element power supply and temperature measurement unit using a Pt-1000 type detector.

3.2.2. Main parameters

The current source for the LED supply is a stabilised source with discreteness of current adjustment of 30×10^{-6} A. The stability of the current source is 10^{-4} A for 10 hours of continuous operation. The accuracy of the current adjustment is equal to 10^{-4} A. Discreteness of the Peltier element power supply current adjustment is 50×10^{-6} A. The little pitch of the Peltier element current adjustment provides a high-precision stabilisation of LED temperature even at a slight change in ambient temperature. Discreteness of the temperature measurement by means of a thermal resistor is 0.01 °C.

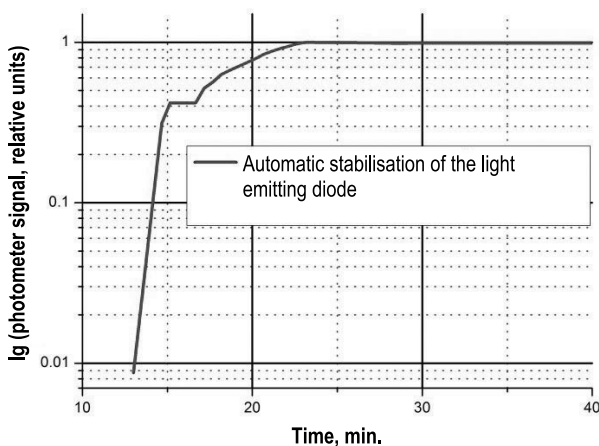

Fig.4. LS during operating mode

The control device generates control signals for the Peltier element power supply based on the LED temperature change data.

The stability of the LED power supply current source was determined by means of voltage difference measurement on the external shunt resistor. To measure voltage, a 3458A *Agilent* voltmeter was selected. An electric resistor coil *P310* with a rated resistance of 0.1 Ohm was used as the shunt. To exclude the error associated with the shunt heating, its temperature was controlled in the measurement process. A stability diagram of the current source for the LED power supply is given in Fig. 3. It can be seen from the diagram that deviation from the current average value is ± 0.01 %, and instability during seven hours of operation is less than 0.005 %. LED temperature stability using the described control device is ± 0.01 °C at room temperature of 22 ± 2 °C.

4. STUDY OF THE PHOTOMETRIC PARAMETERS OF THERMALLY STABILISED LEDS USING POWER SUPPLY BY MEANS OF A SPECIALLY DEVELOPED CONTROL DEVICE

This article describes studies of photometric parameters of a LED LS with the first type of structure (with the tube of polytetrafluoroethylene and matte glass).

Reaching an operation mode, including time for temperature stabilisation is no more than 0.5 h. A diagram of the LED reaching the operation mode with rated current of 1 A and stabilisation temperature of 36 °C is presented in Fig. 4. Stability of the

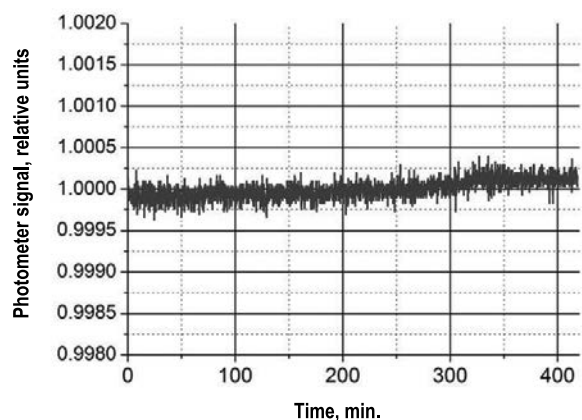

Fig.5 LS luminous intensity stability for 7 hours of continuous operation

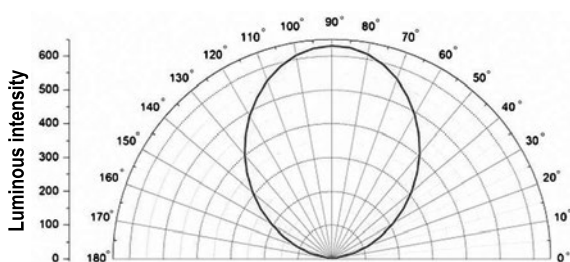

Fig. 6. LS luminous intensity spatial distribution

LS luminous intensity is given in Fig. 5. It is equal to $\pm 0.02\%$ for 7 h of LS continuous operation.

Luminous intensity reproducibility is less than 0.02% for more than 30 cycles of switching-on and re-alignment. Luminous intensity of the specimens is 631cd [7].

Luminous flux stability and reproducibility is similar to the luminous intensity stability and reproducibility as luminous flux unit is transmitted by goniophotometric method [7–9]. This specimen luminous flux value is 1500 lm.

Fig. 6 shows the spatial distribution of luminous intensity, which allows drawing a conclusion that LS solid light distribution is uniform, because it is provided by a plastic tube and matte glass insert. The non-uniformity of luminous intensity in various meridian planes for azimuthal angles within an interval of $\pm 70^\circ$ relative to the LS photometric axis is no more than 2% .

Fig. 7 shows dependences of LS colour co-ordinates on the angle of observation. The change in colour co-ordinates depending on the observation angle is $\Delta x = 0.006$ and $\Delta y = 0.005$, which is evidence of a high spectral uniformity of LS solid light distribution. LS spectral uniformity allows minimising the error connected with inaccuracy of the photometer correction according to the visibility curve of the human eye. LS correlated colour temperature is 3500 K.

5. CONCLUSION

In this article, standard thermally stabilised LSs based on powerful LEDs are presented, which were developed and studied at the VNIIOFI Federal State Unitary Enterprise. Their differential feature is a greater electric power of stabilised LEDs, which can reach 78 W, whereas power of other thermally stabilised LEDs was no more than 5 W [5, 6]. During the research, specimens were developed and

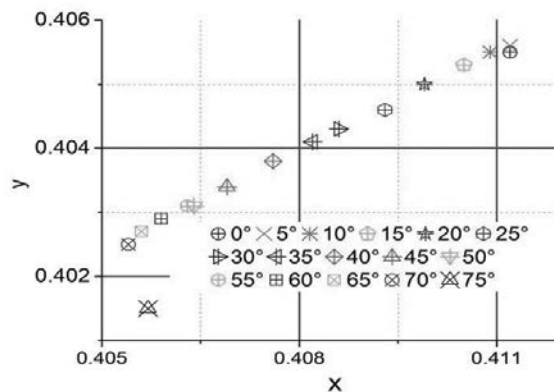

Fig. 7. LS colour co-ordinate dependence on the observation angle

studied with luminous fluxes from 10 to 2500 lm. The study's results have show high stability and reproducibility of the new LSs. In future, introduction of these LSs in the Measuring instrument state register is planned in order to use them for verification and calibration of the photometric systems used for measuring parameters of LEDs and products based on these.

The work is performed using equipment of the Centre of Collective Use of High-Precision Measuring Technologies in the Photonics Field (ckp.vniiofi.ru) established on the VNIIOFI Federal State Unitary Enterprise basis and supported by the Ministry of Education and Science of the Russian Federation within Agreement #14.595.21.0003 of 8/28/2017 (unique identifier RFMEFI59517X0003).

REFERENCES

1. Zwinkels, L.C. CCPR Activities Related to LED-based Calibration Standards // CIE Lighting Quality and Energy Efficiency Conference. Melbourne, Australia, 2016. https://www.researchgate.net/publication/298212170_CCPR_Activities_Related_to_LED-based_Calibration_Standards.
2. Blattner, P. CIE report to CCPR2016. https://www.bipm.org/cc/CCPR/Allowed/23/CCPR16_42_CIE_report_to_CCPR.pdf
3. Ohno, Y. et al. LED Sources in Photometry at NIST // Report to CCPR2016. https://www.bipm.org/cc/CCPR/Allowed/23/CCPR16_47_Y_Ohno_LED_sources_in_photometry_at_NIST_for_CCPR_2016-11-07.pdf
4. Zama, T. NMIJ Research Activities relevant to LED Sources for Photometry // Report to CCPR2016. https://www1.bipm.org/cc/CCPR/Allowed/23/CCPR16_46_NMIJ_Activities_LED_sources_Photometry.pdf

5. Gerloff, T., Lindemann, M., Shirokov, S., Taddeo, M., Pendsa, S., Sperling, A. Development of a new high-power LED transfer standard // CIE Proceedings 2012. https://www.researchgate.net/publication/293172050_Development_of_a_new_high-power_LED_transfer_standard.

6. Lindemann, M., Maass, M. Photometry and Colorimetry of Reference LEDs by Using a Compact Goni-

ophotometer // MAPAN, Journal of Metrology Society of India, Vol. 24, No. 3.

7. CIE127; 2007 (2nd edition); Measurement of LEDs.

8. Reference book on lighting engineering. Under the editorship of Yu.B. Aysenberg. / Moscow: Znak, 2006, 972 p.

9. Tikhodeev P.M. Light measurements in the light engineering / Moscow-Leningrad: State energy publishing house, 1962, 464 p.



Eugene A. Ivashin

graduated from the MSTU Stankin. At present, he is a leader engineer at the VNIIOFI Federal State Unitary Enterprise



Boris B. Khlevnoy,

Ph.D. Graduated from the Moscow State University of M.V. Lomonosov. At present he is the Chief of the Laboratory of the Scientific and Research Department of Radiometry, Photometry, Spectrophotometry and Colorimetry at VNIIOFI Federal State Unitary Enterprise, an active member in COOMET and CCPR (CIPM) activities, especially as a leader of key international comparison organizing in field of spectroradiometry



Stanislav S. Shirokov

graduated from the Moscow State University of M.V. Lomonosov. He is a senior engineer at the VNIIOFI Federal State Unitary Enterprise



Eugene V. Tyshchenko,

graduated from the Moscow State University of M.V. Lomonosov. At present, he is a master's student at the Moscow State University of M.V. Lomonosov